

Kennesaw, GA 30144 U.S.A.

NO: 539507-00	REV: 1	PAGE: 1 of 3	DATE ISSUED: 8-8-2000
WRITTEN BY: A KEY	DATE: 8-8-2000	APPROVED BY:	DATE:
SUBJECT: KR535 TABBER BUMP TURN INSTRUCTIONS			

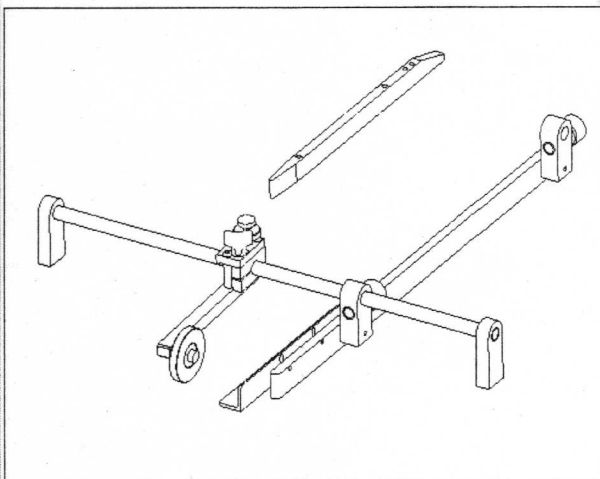
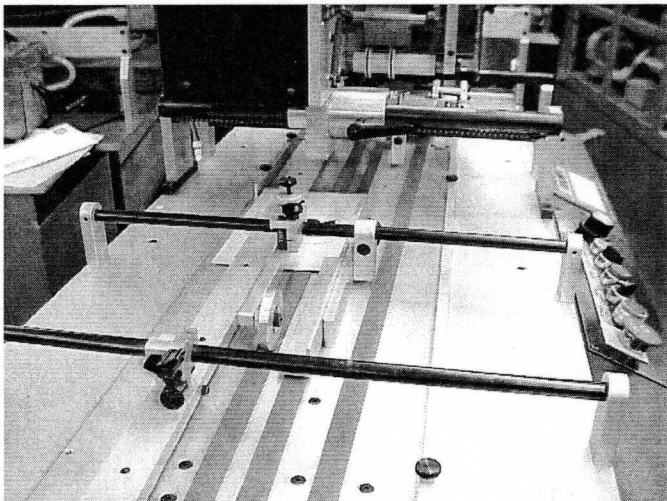

537503-01 Bump Turn Kit

Bump Turn Setup Procedure

1. Folded product must enter the tabber belts folded edge first. Adjust the bump turn side guide (see **Figure 1**) to fit the width of the product (see **Figure 2**). The side guide must not line up over a conveyor belt. The two center belts can be adjusted to miss the side guide by moving the outfeed crown drive rollers. The belts will track anywhere you move the drive crown rollers.

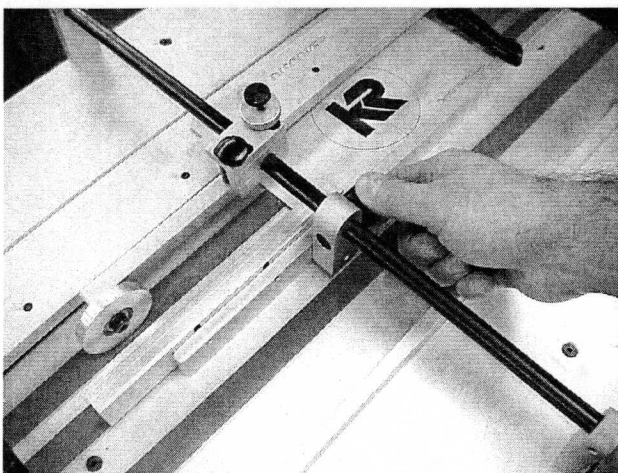

Figure 1

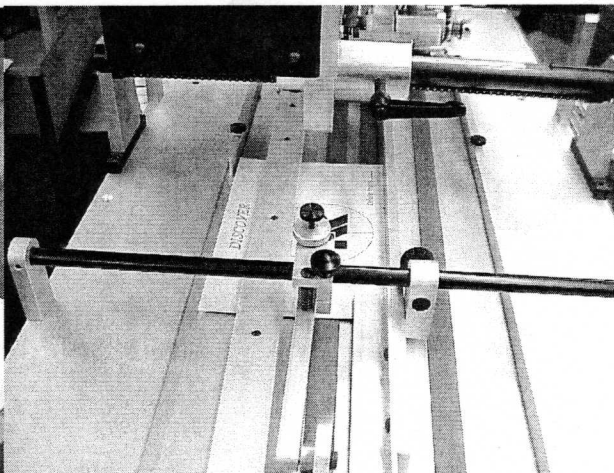

Figure 2

2. Adjust the tabletop (see **Figure 3**) so that the product hits the bump turn on center (see **Figure 4**).

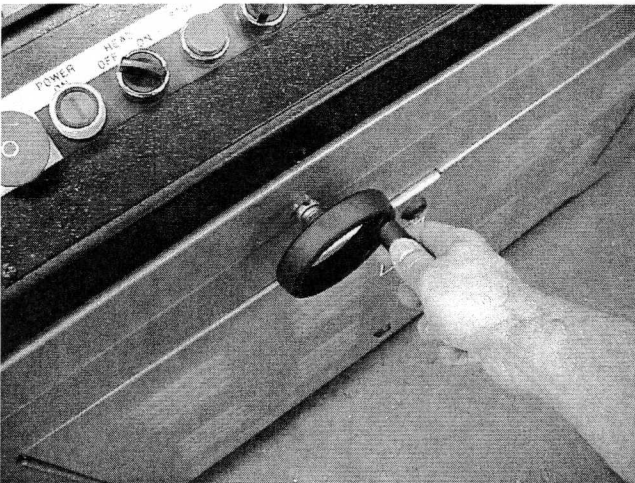

Figure 3

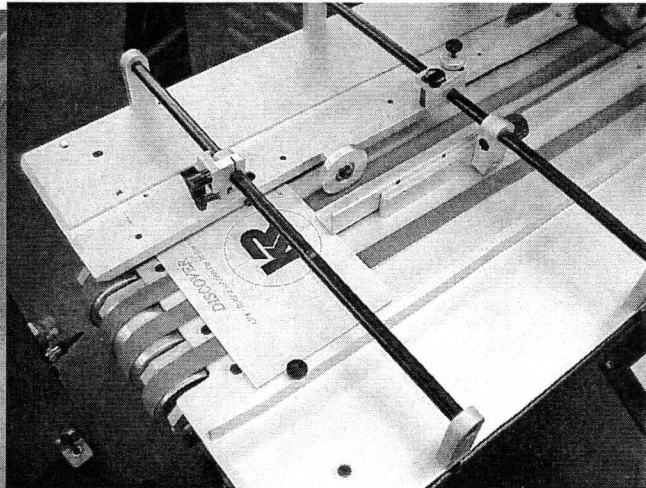

Figure 4

3. Adjust the bump turn pinch roller (see **Figure 5**) so that it rides over a conveyor belt. Apply slight pressure on the pinch roller bracket to load the spring causing the roller to press down on the conveyor belt.

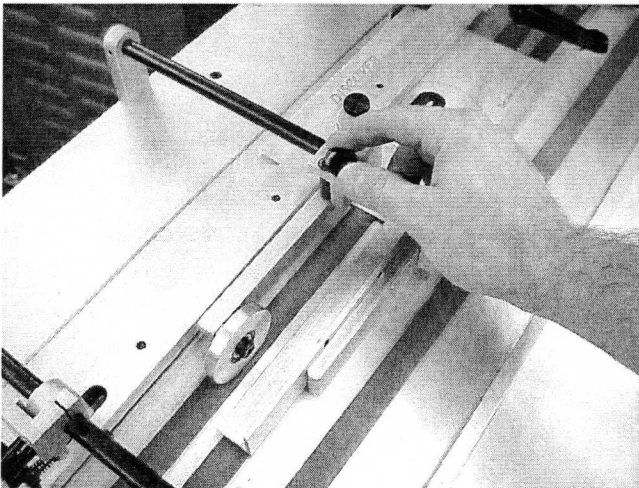

Figure 5

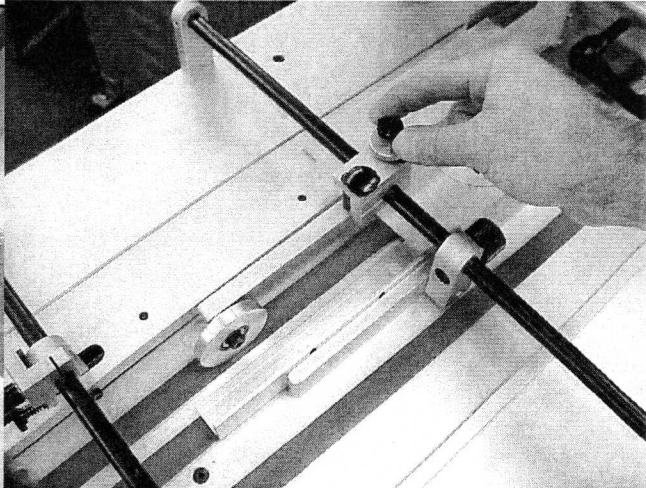

Figure 6

4. Adjust the pinch roller (see **Figure 6**) so that the roller pinches the product but rests just above the conveyor belt. After adjustment has been made lock the pinch roller in place by turning the locking wheel (see **Figure 7**).

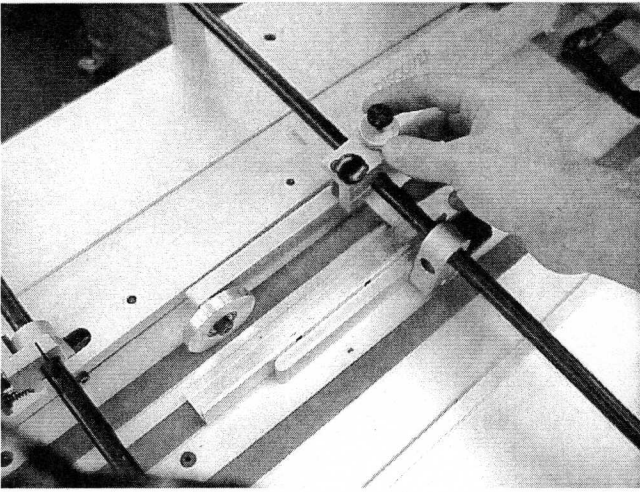

Figure 7

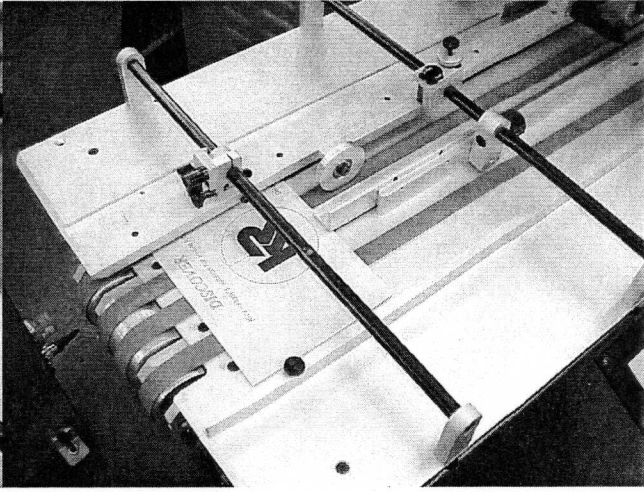

Figure 8

5. Start test running the product with the base set at 100 feet per minute. Momentum helps product complete the bump turn cycle. Different speeds will have to be tested for each product bump turned. Lighter weight product will require slower speeds to prevent damaging the product during the bump turn cycle.
6. Product will flow as seen in **Figure 8** through **Figure 11**.

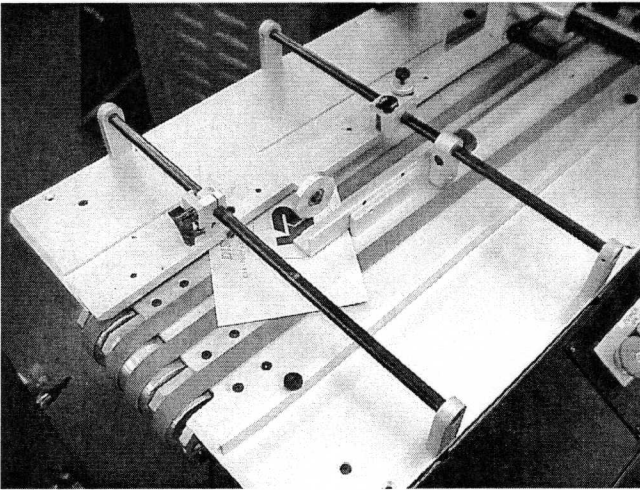

Figure 9

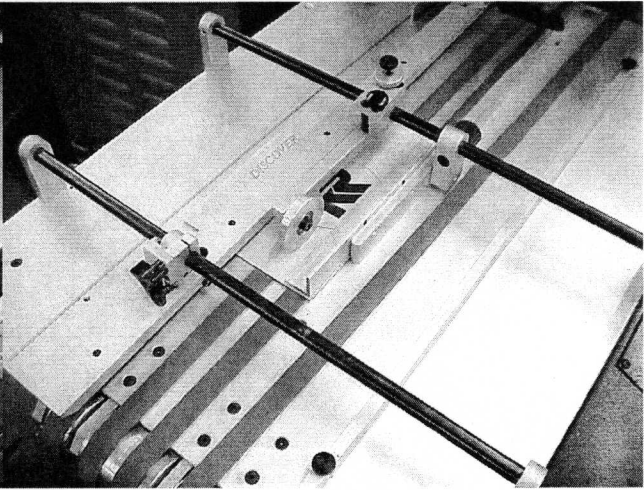

Figure 10

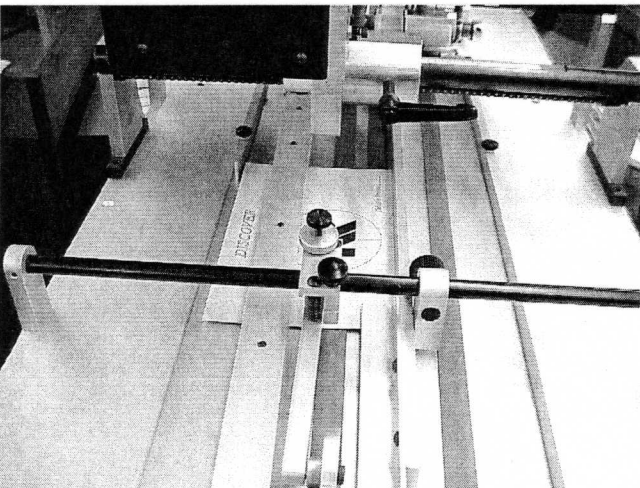

Figure 11